

Styrón
(Styro
balsa)

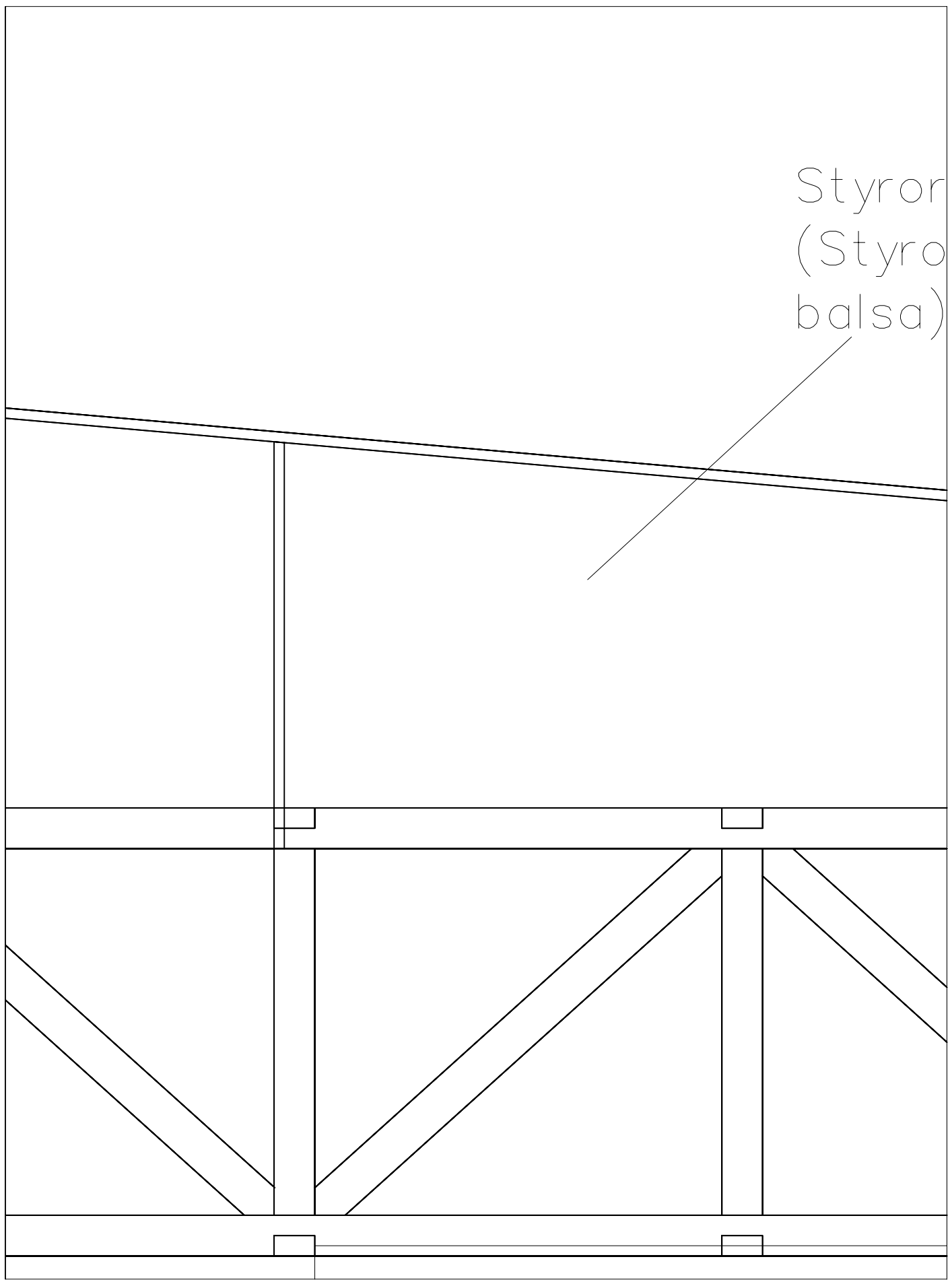

ücken mit 1mm Balsa beplankt
foam back covered with thin

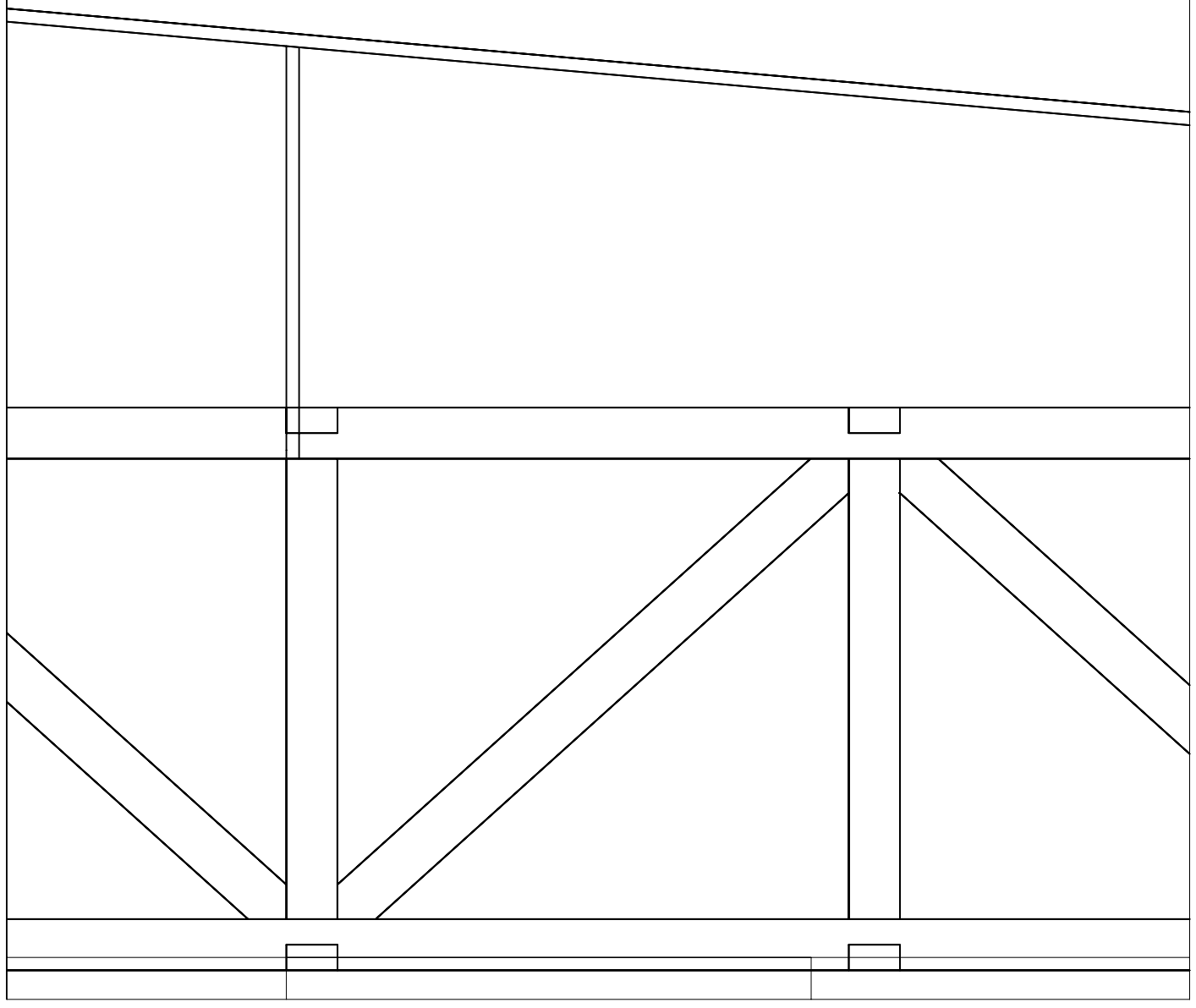

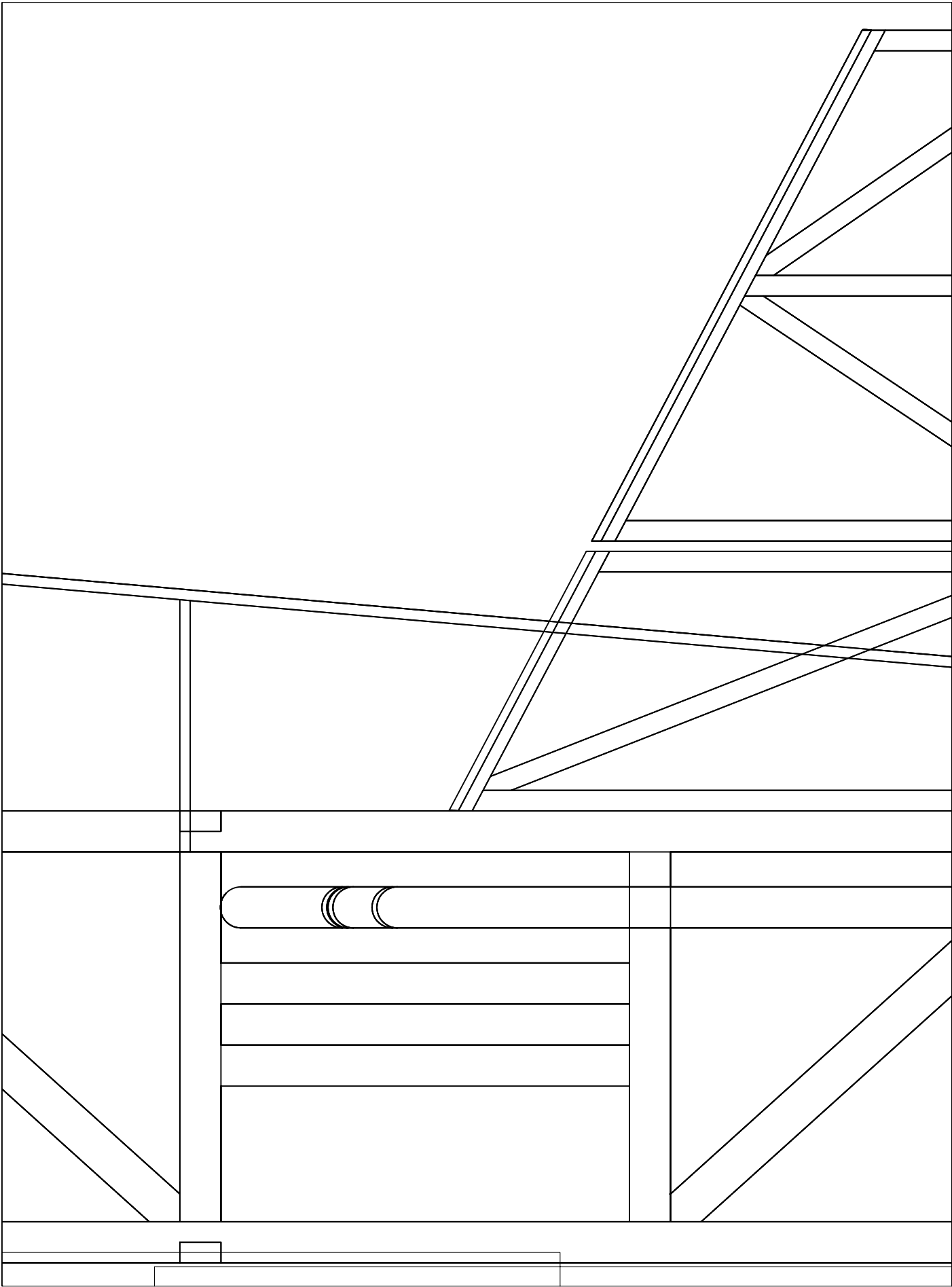

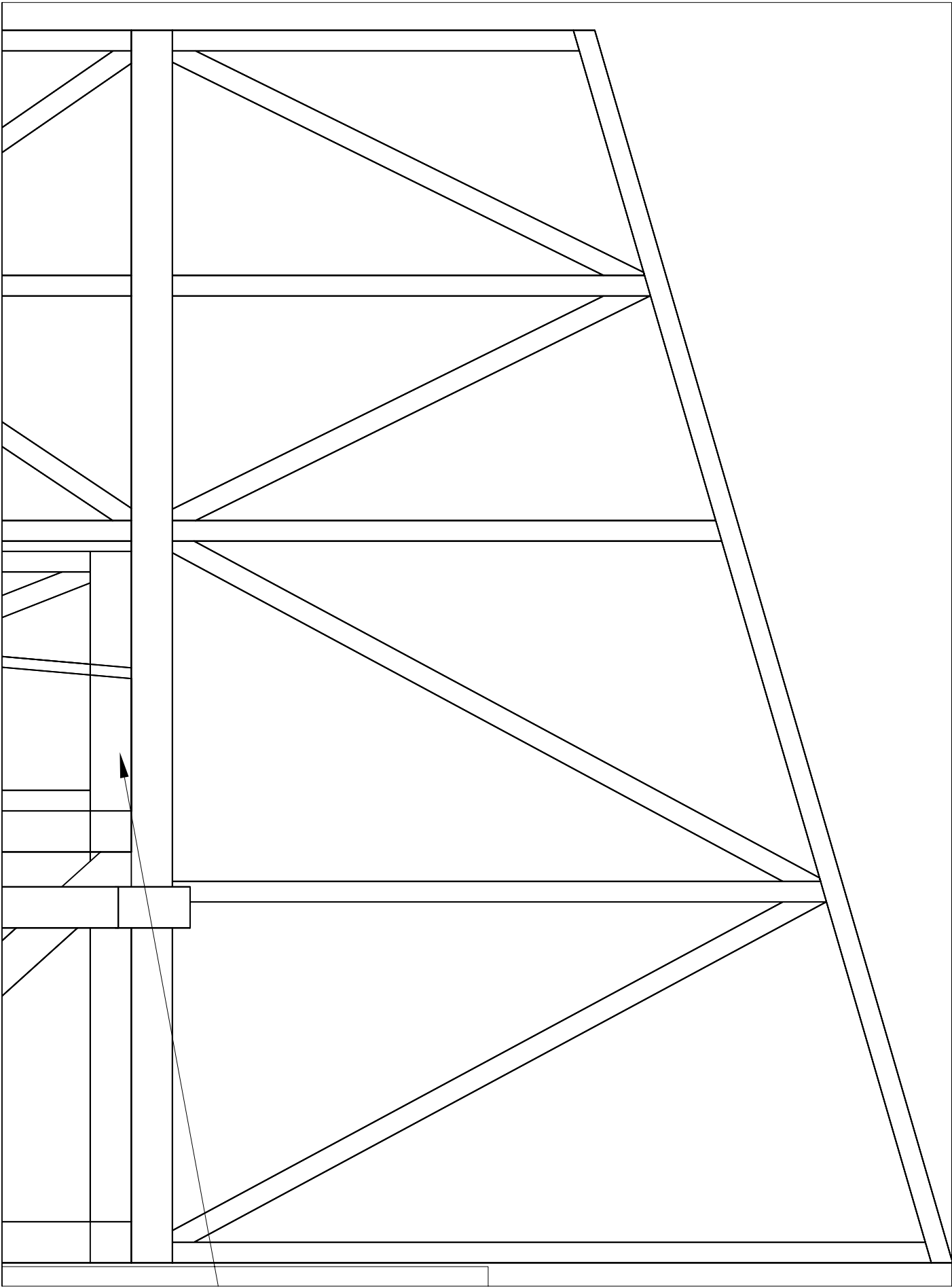

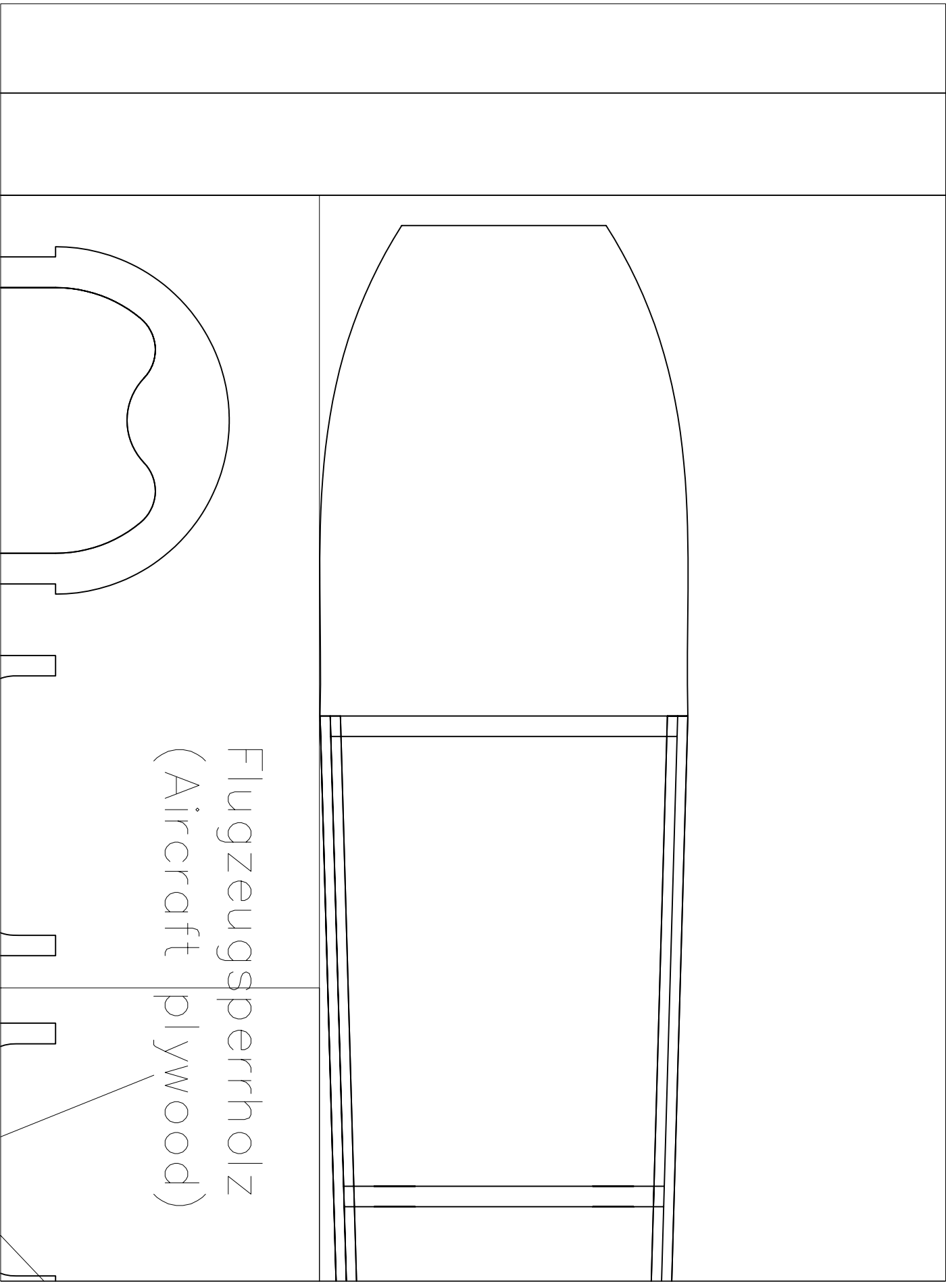

Flugzeugsperrholz
(Aircraft plywood)

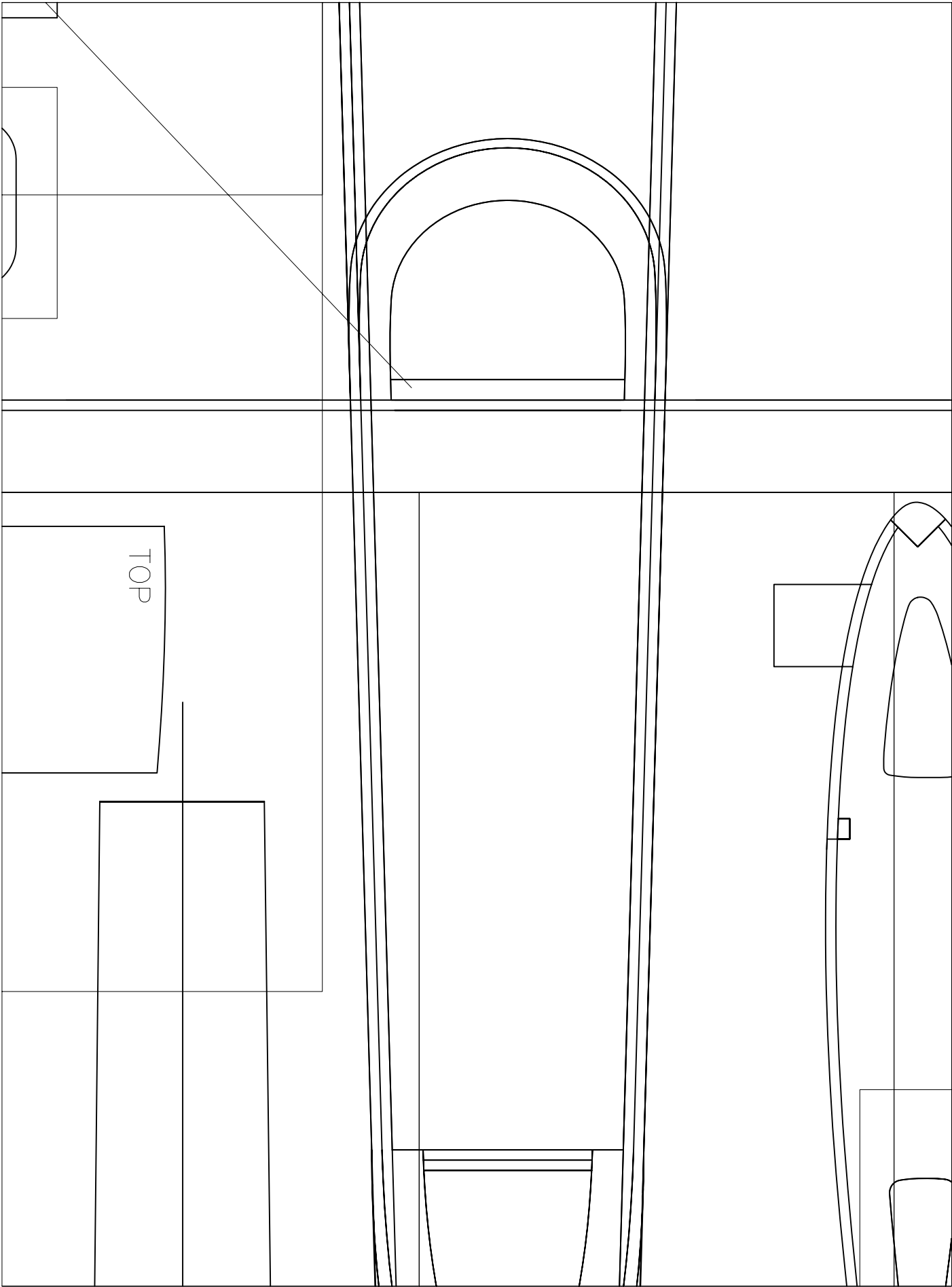

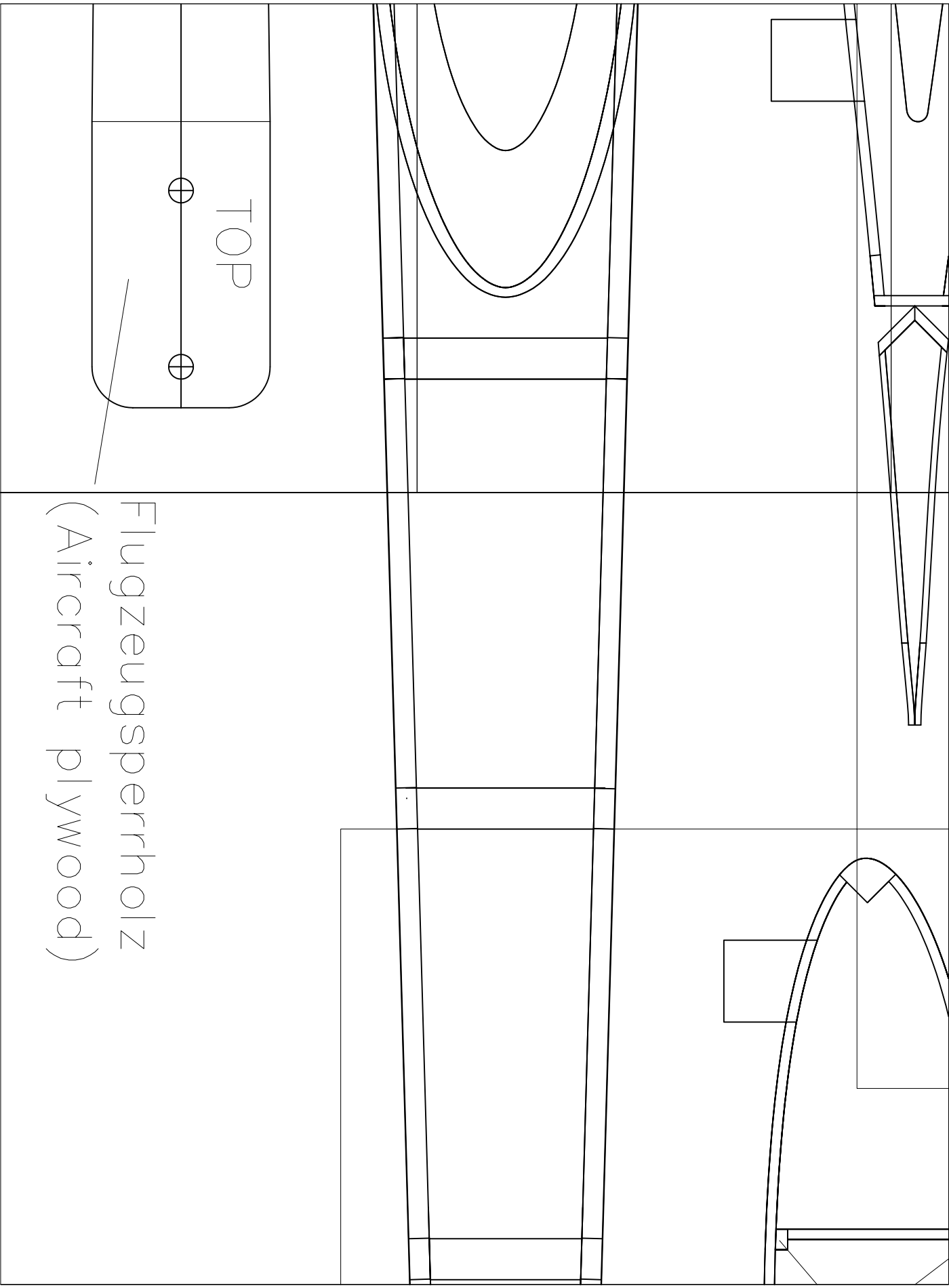

TOP

Kiefernholme
(pine spars)

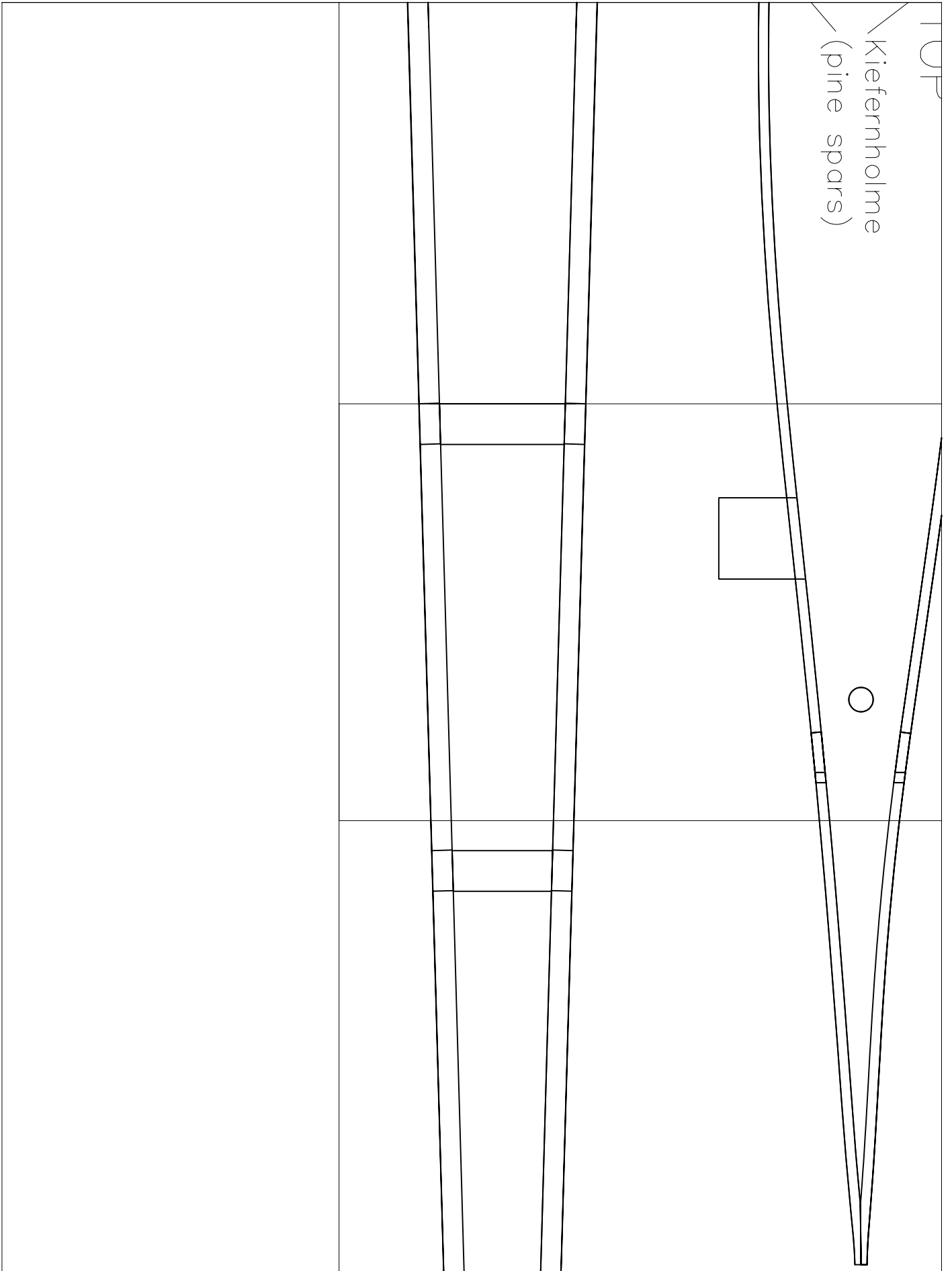
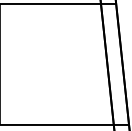

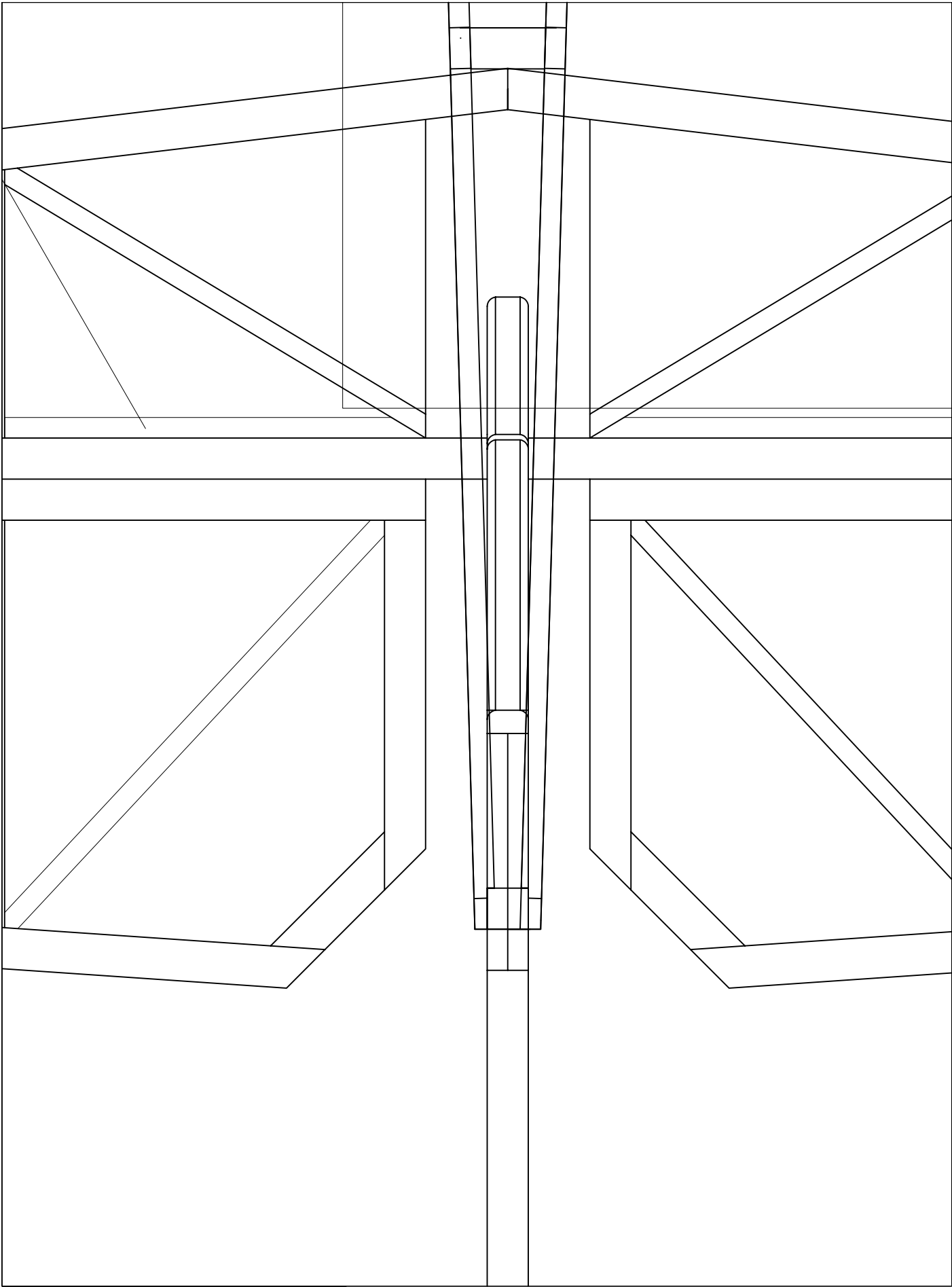

5") Typhoon 15/10 Hacker

Lipoly Weight: 500g 17.6oz

reme Vers 0.2
Michael Sillmann

RCIAL USE!

Blatt

01

Bl.

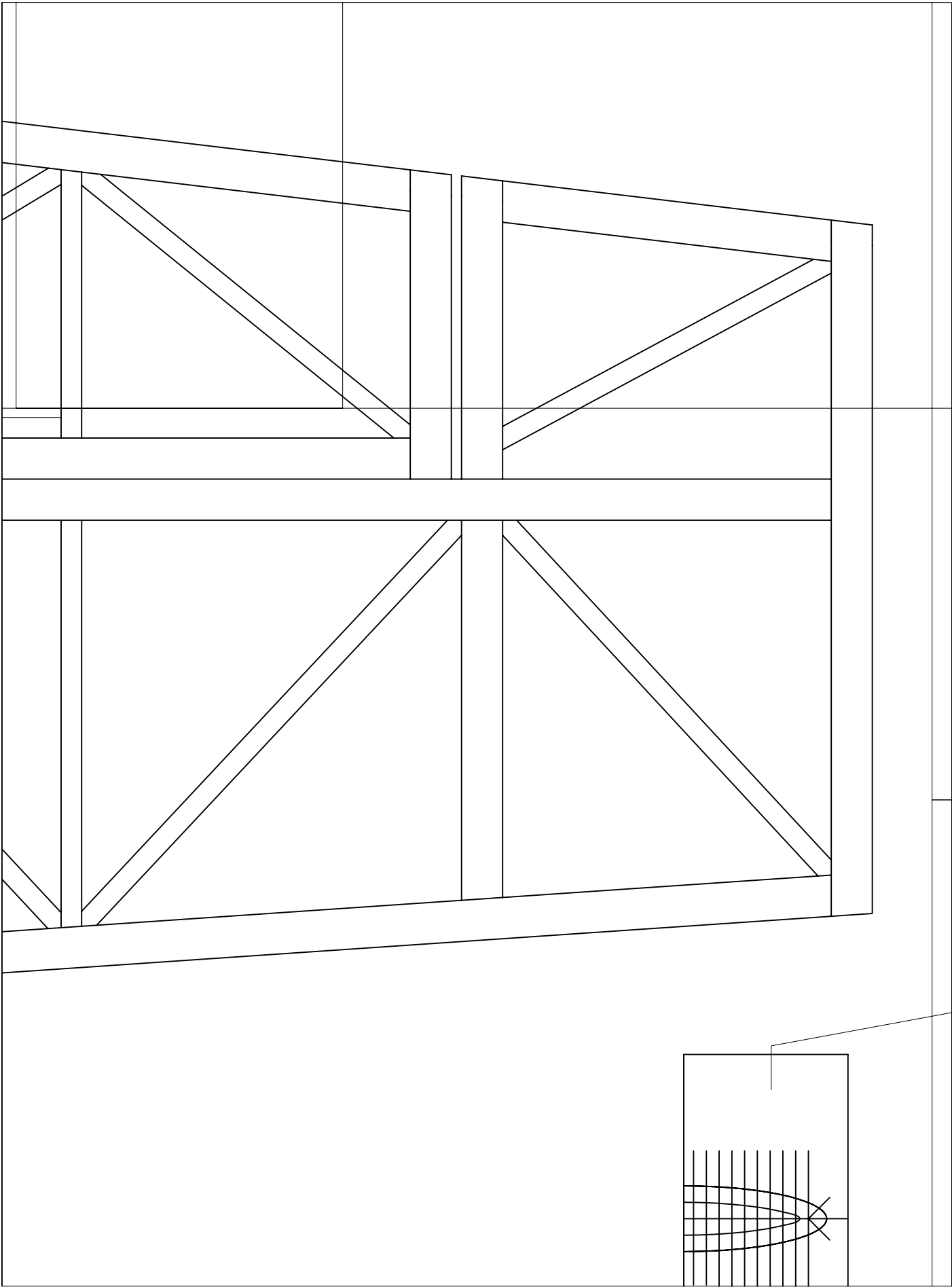

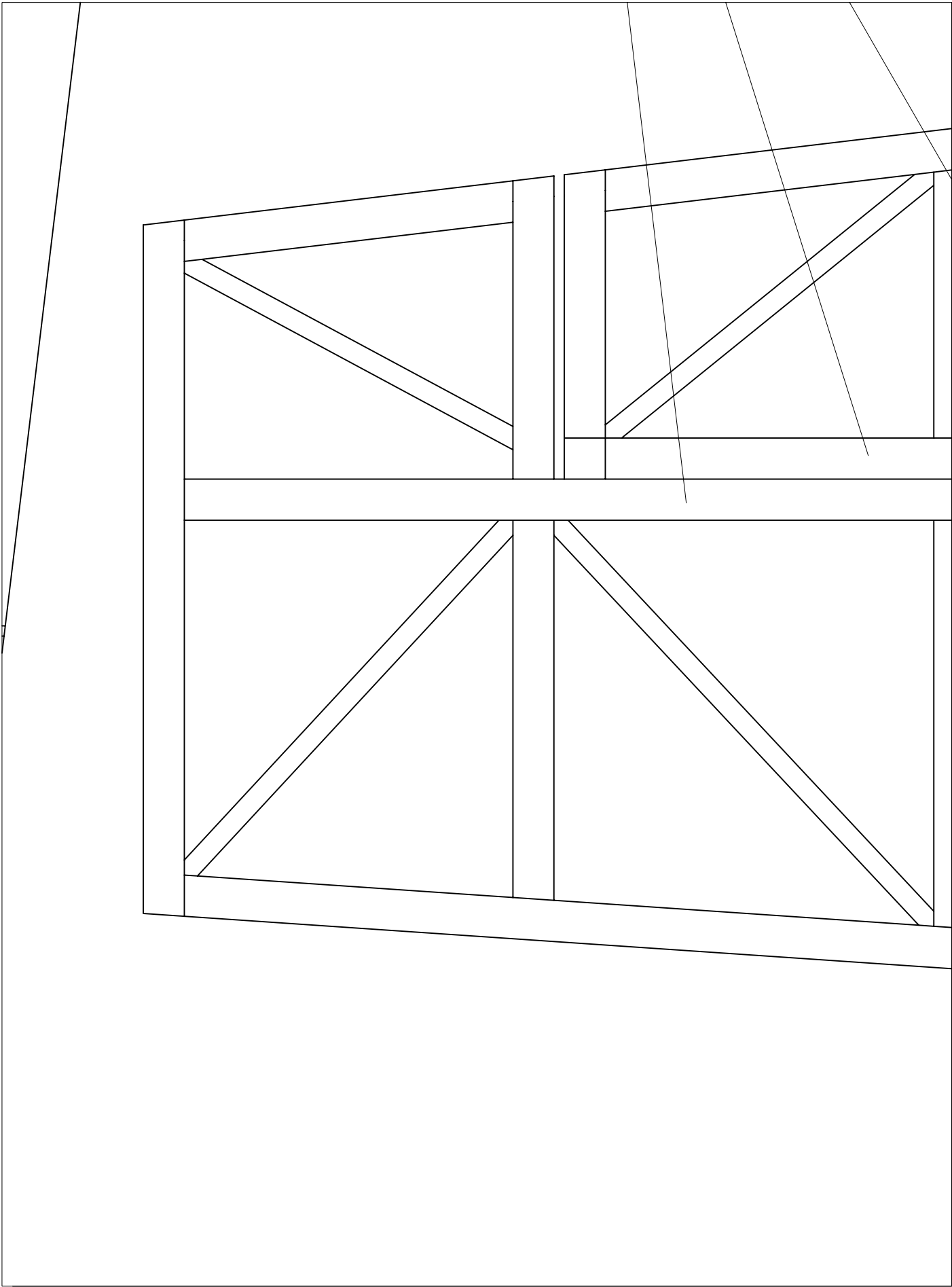

Sperrholz
(plywood)

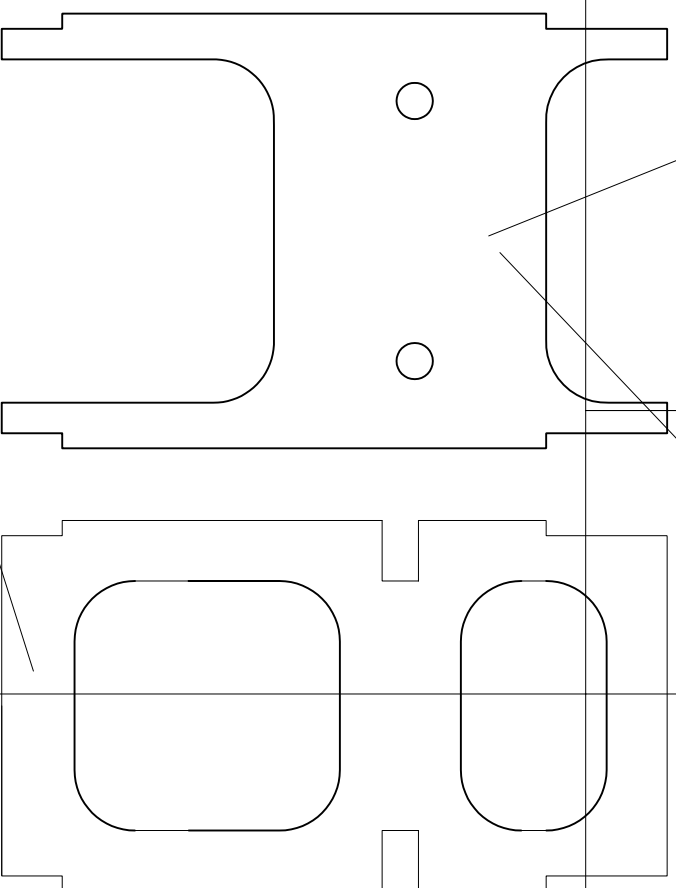

(Birch plywood)

TOP

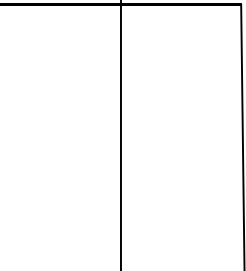
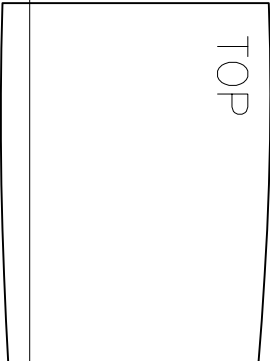

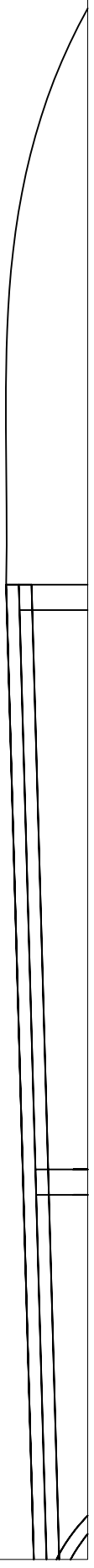

Flugzeugsperrholz
(Aircraft plywood)

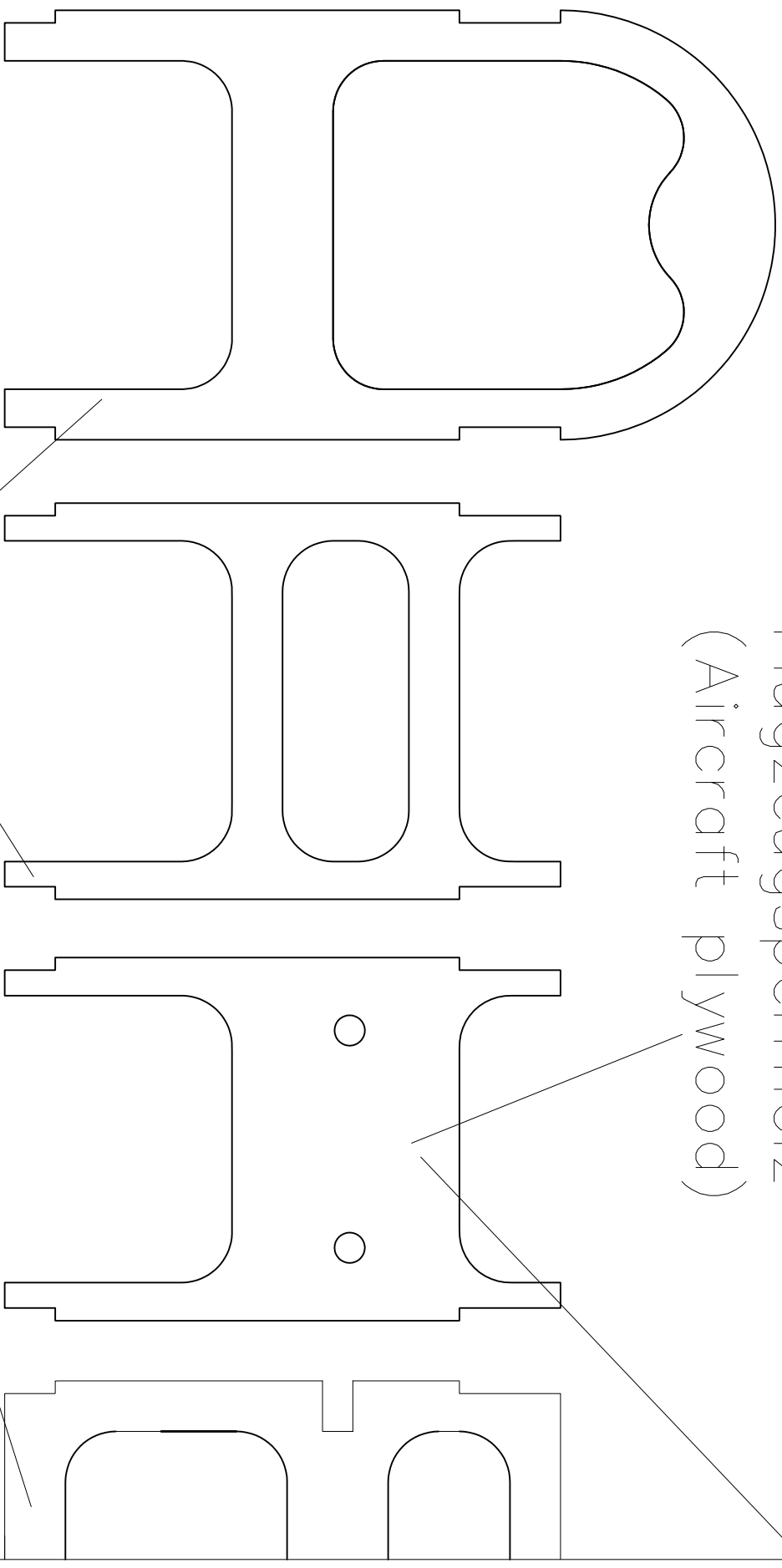

Birke plywood (Birch plywood)

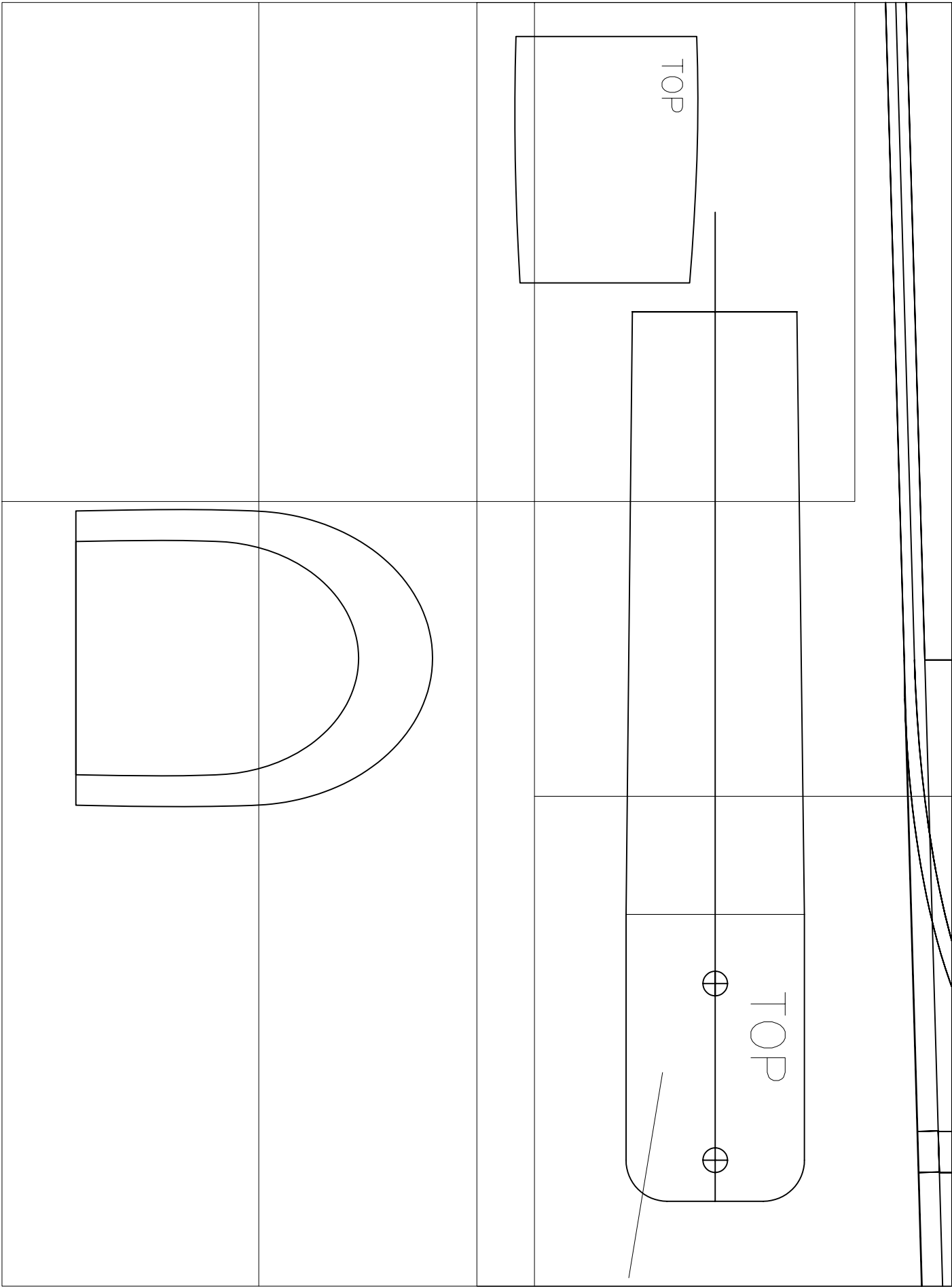

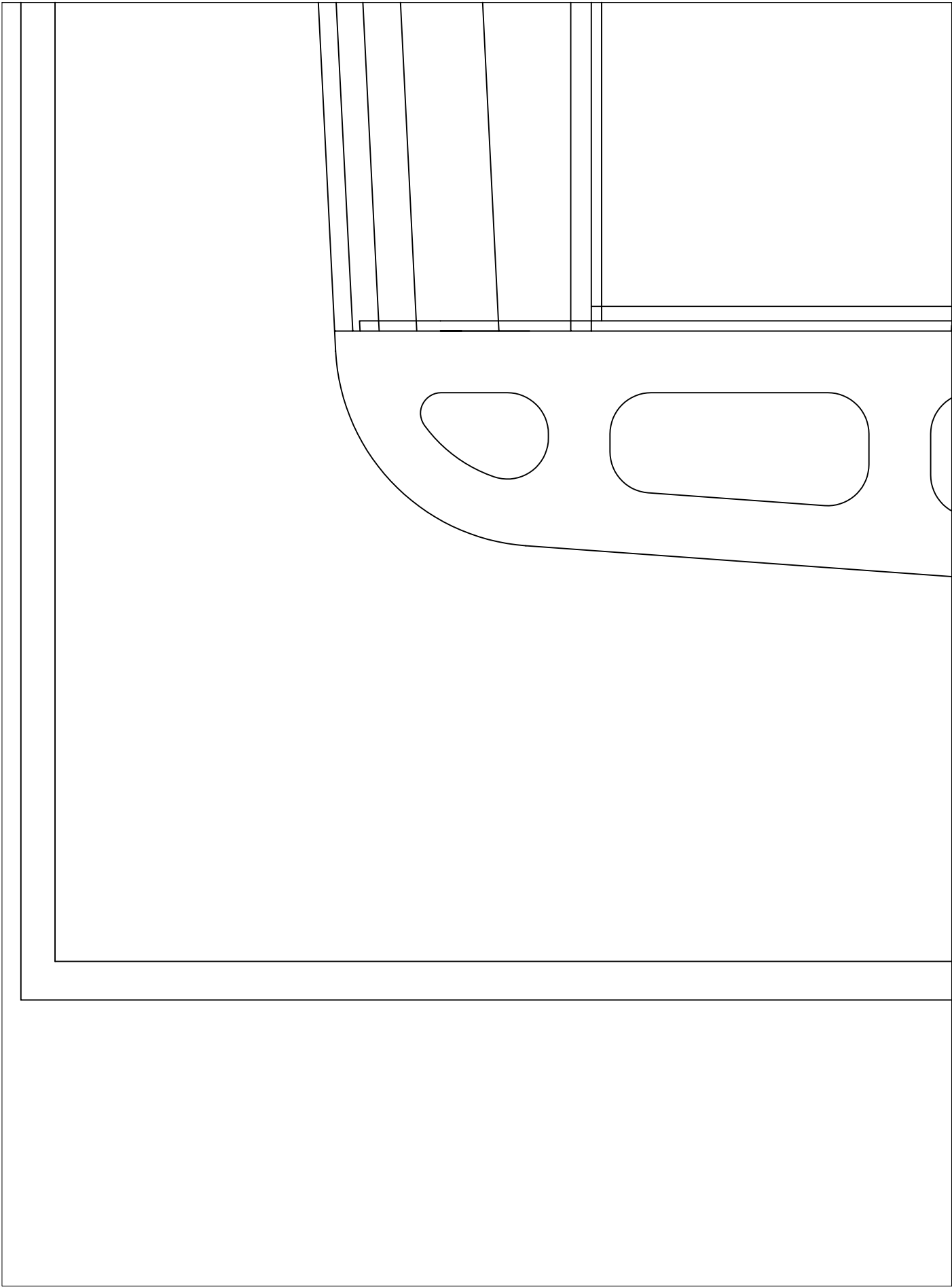

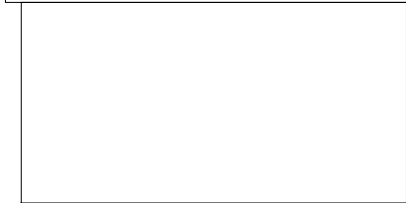
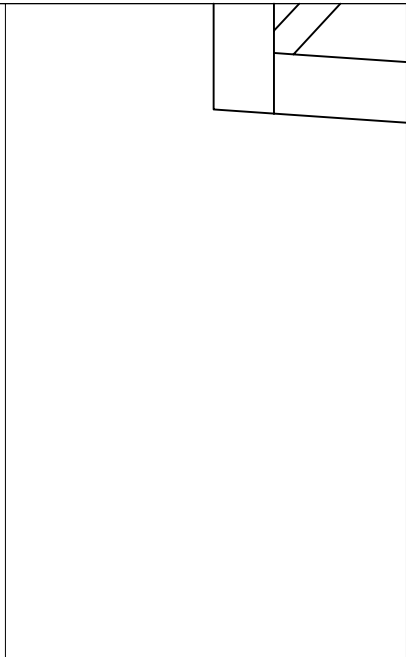
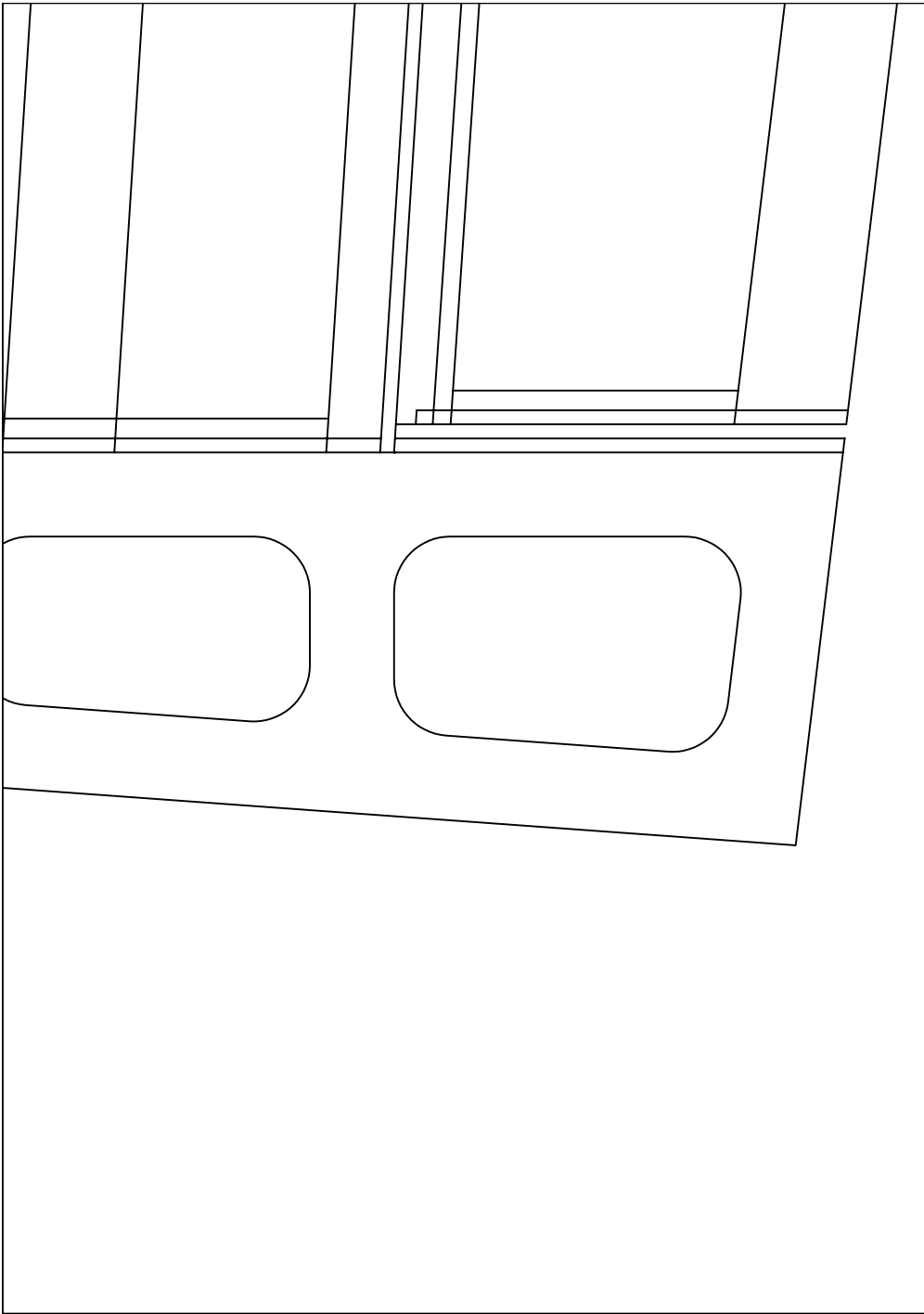

Thanks to Andreas H
for
making the wing pro
AH122M2 !

Zust. *Aenderung* *D*

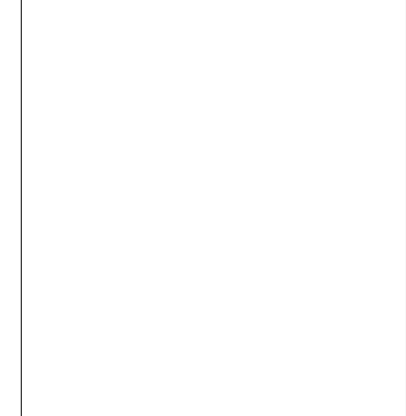
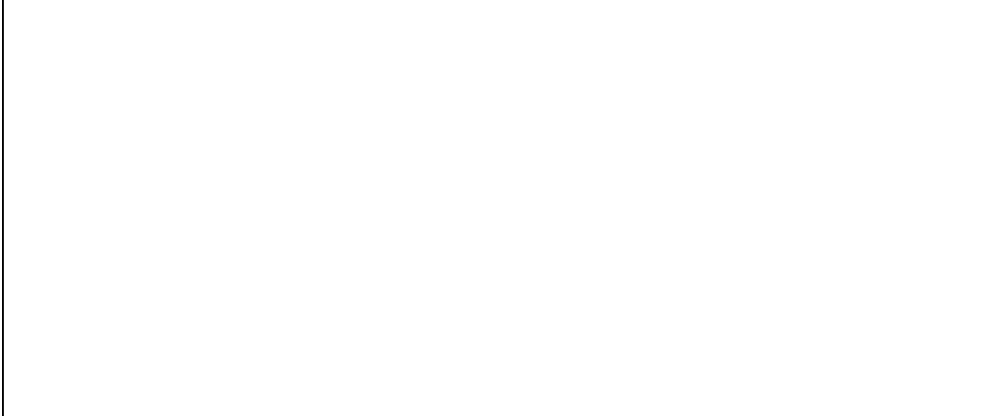

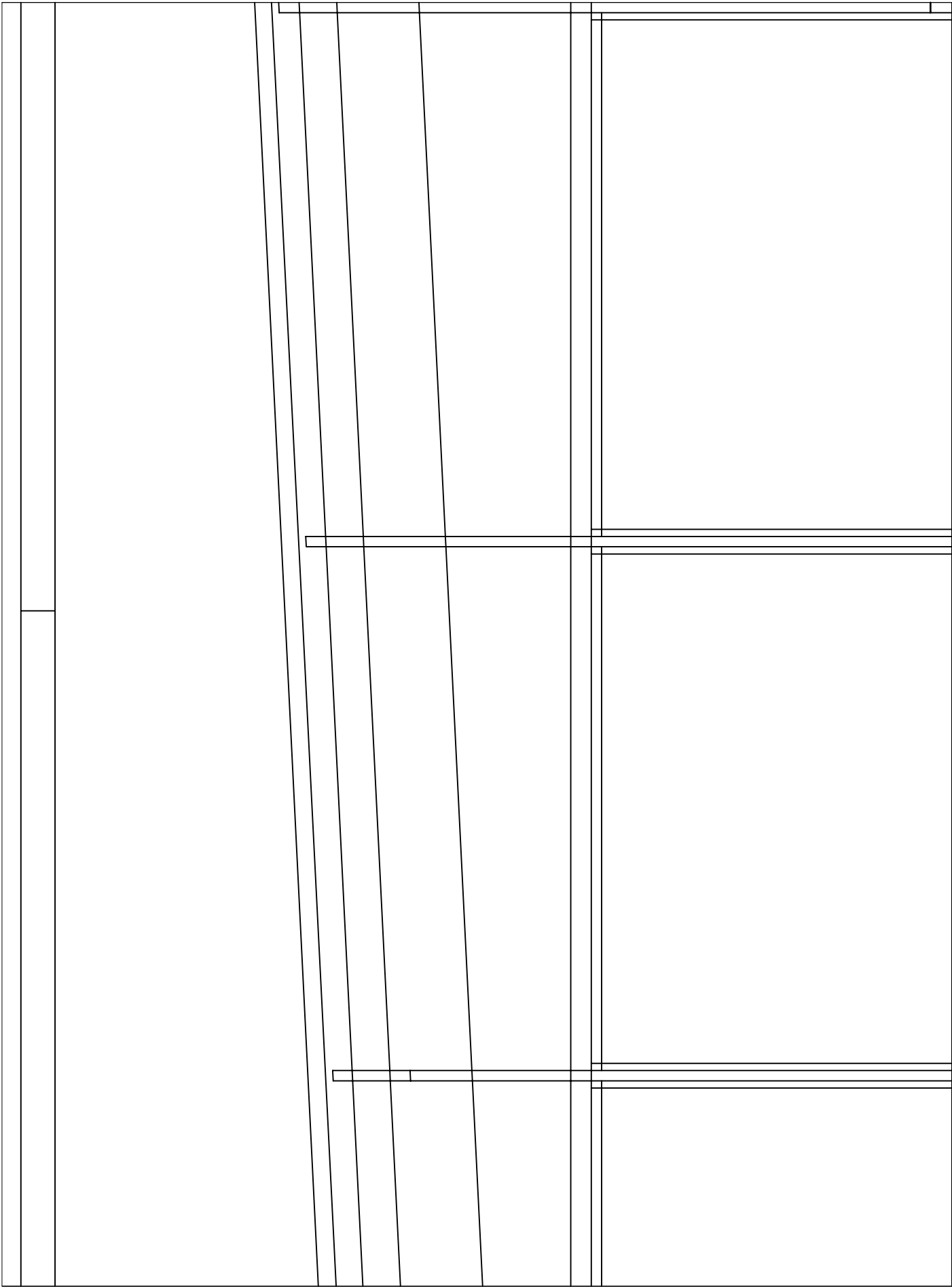

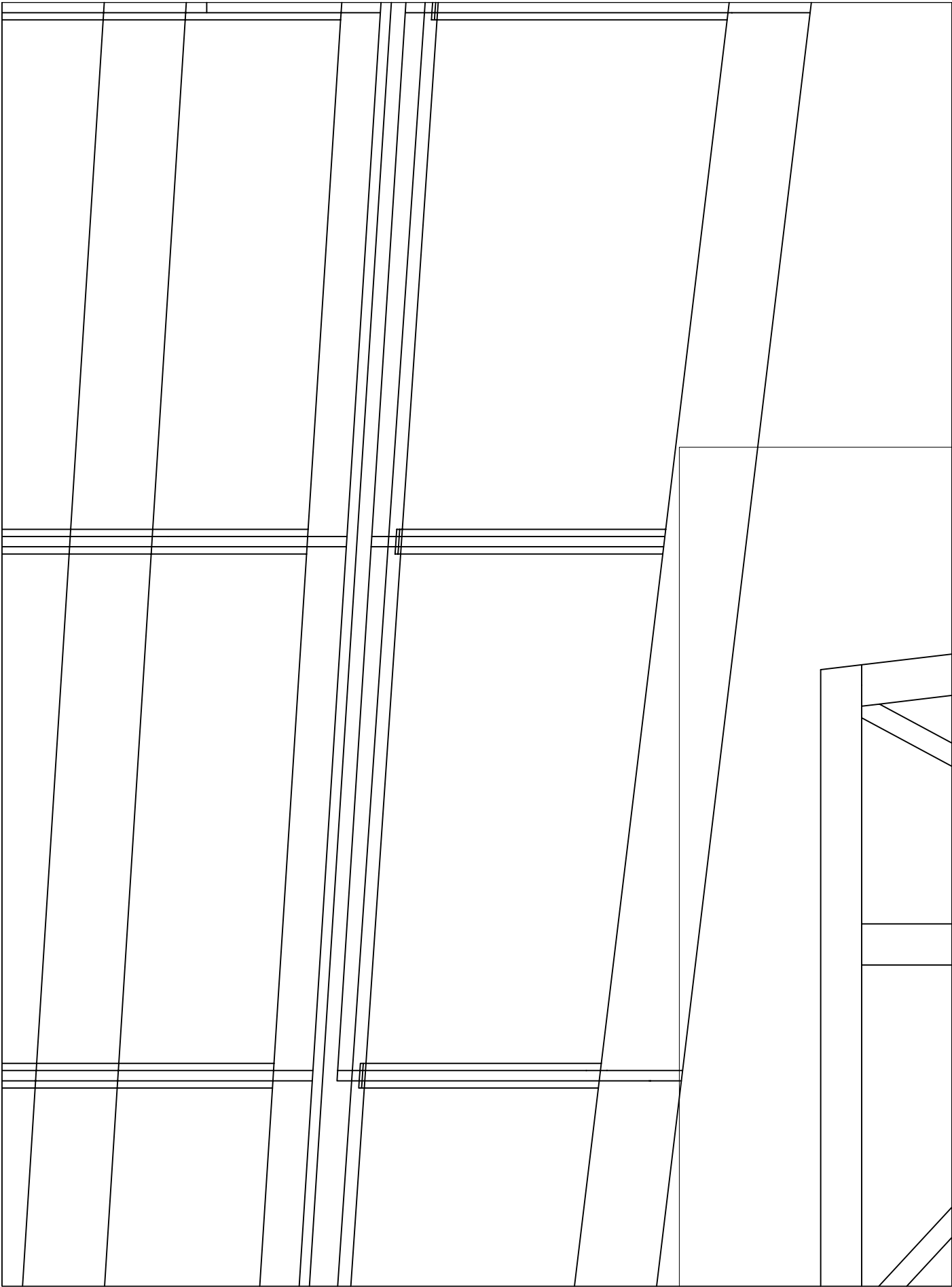

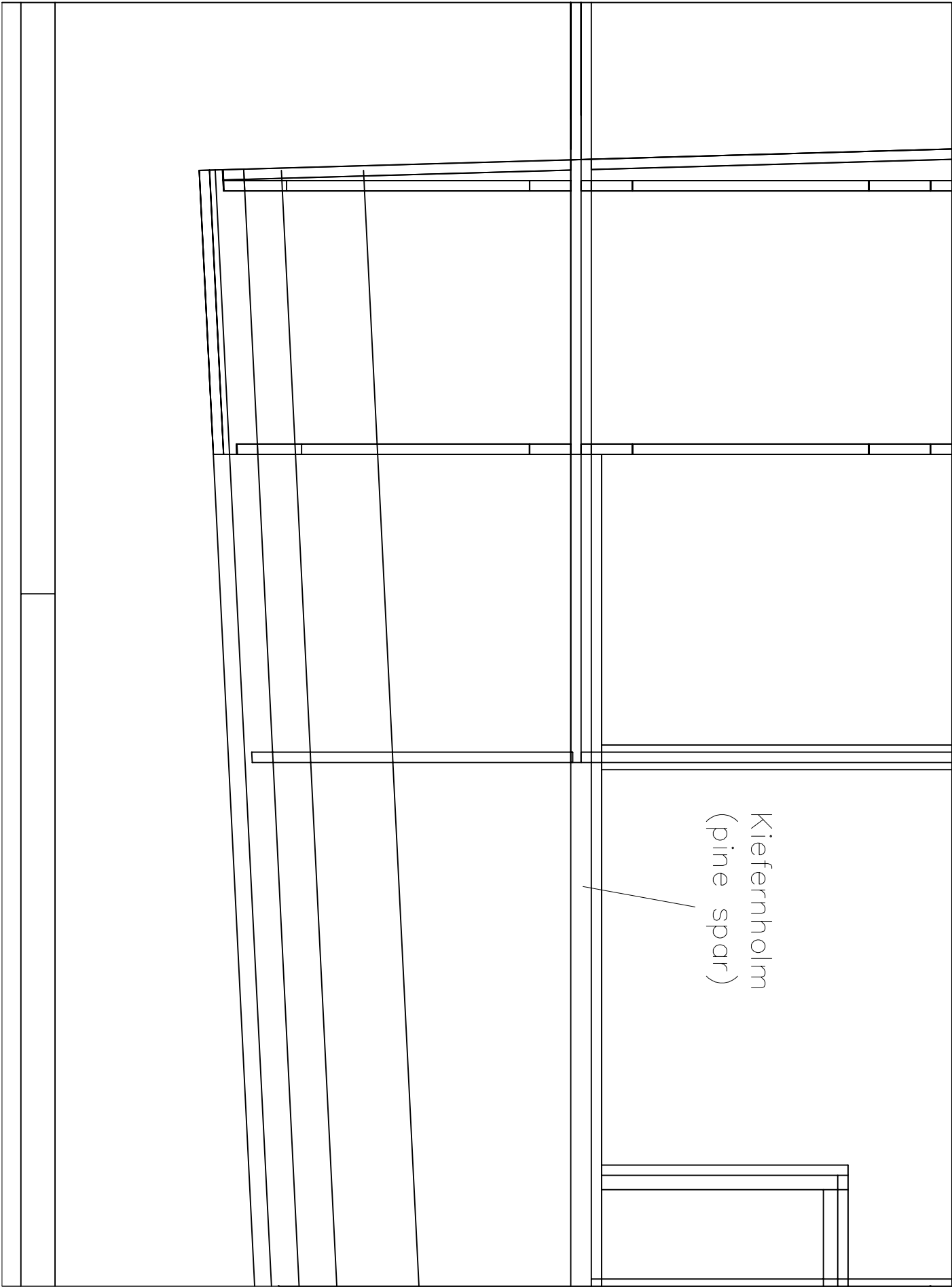

Kiefernholz
(pine spar)

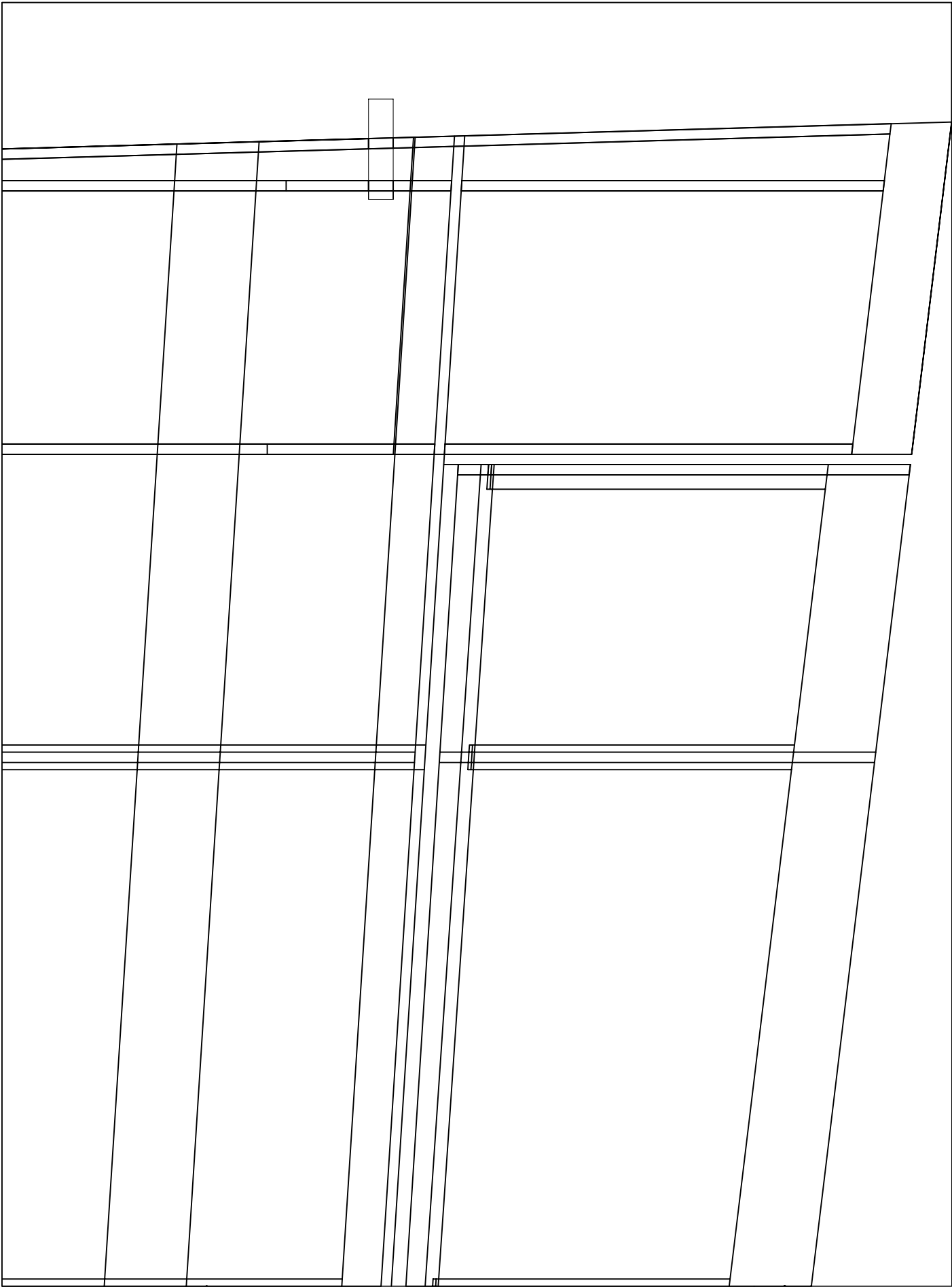

Kiefernholm
(pine spar)

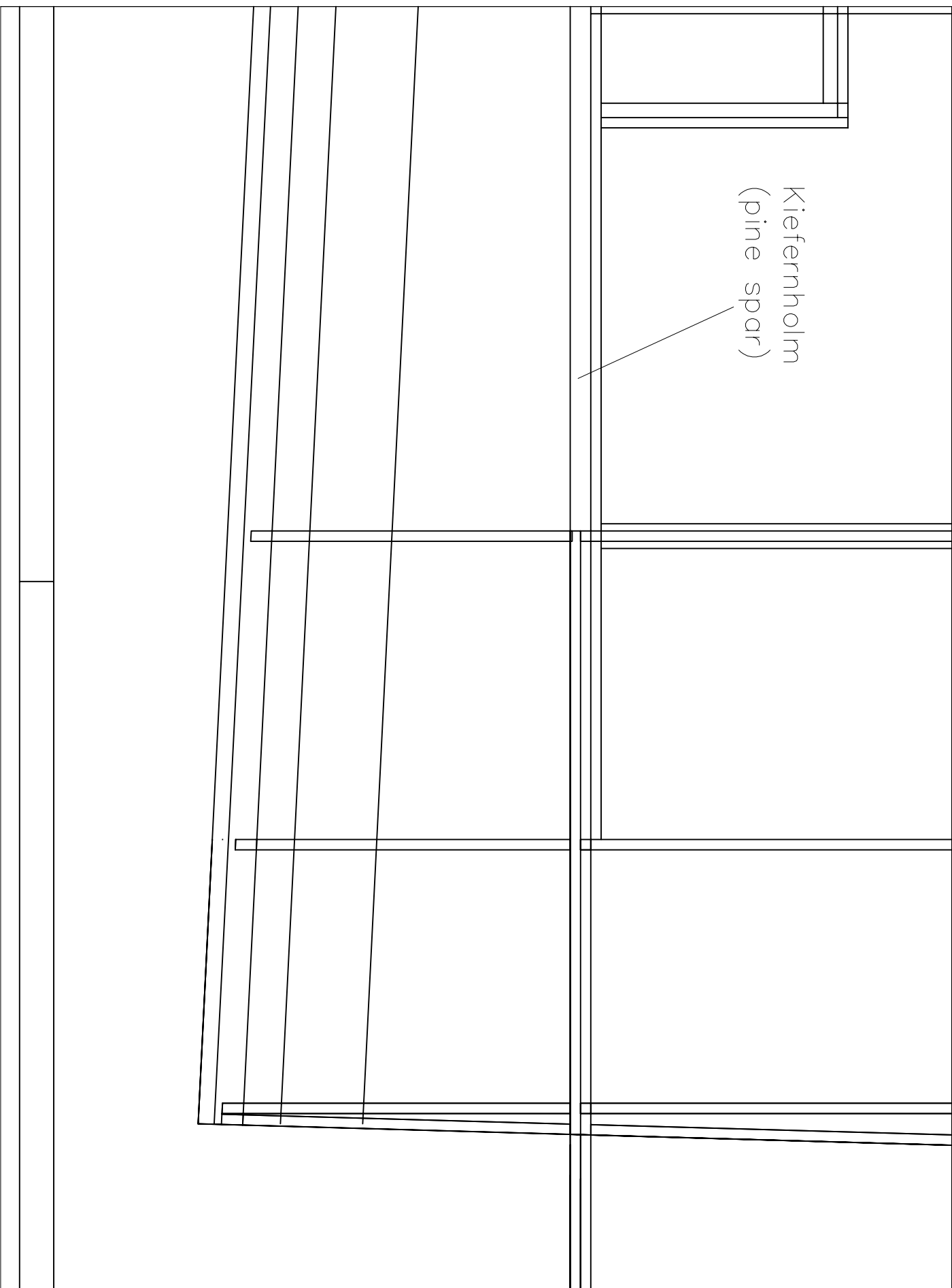

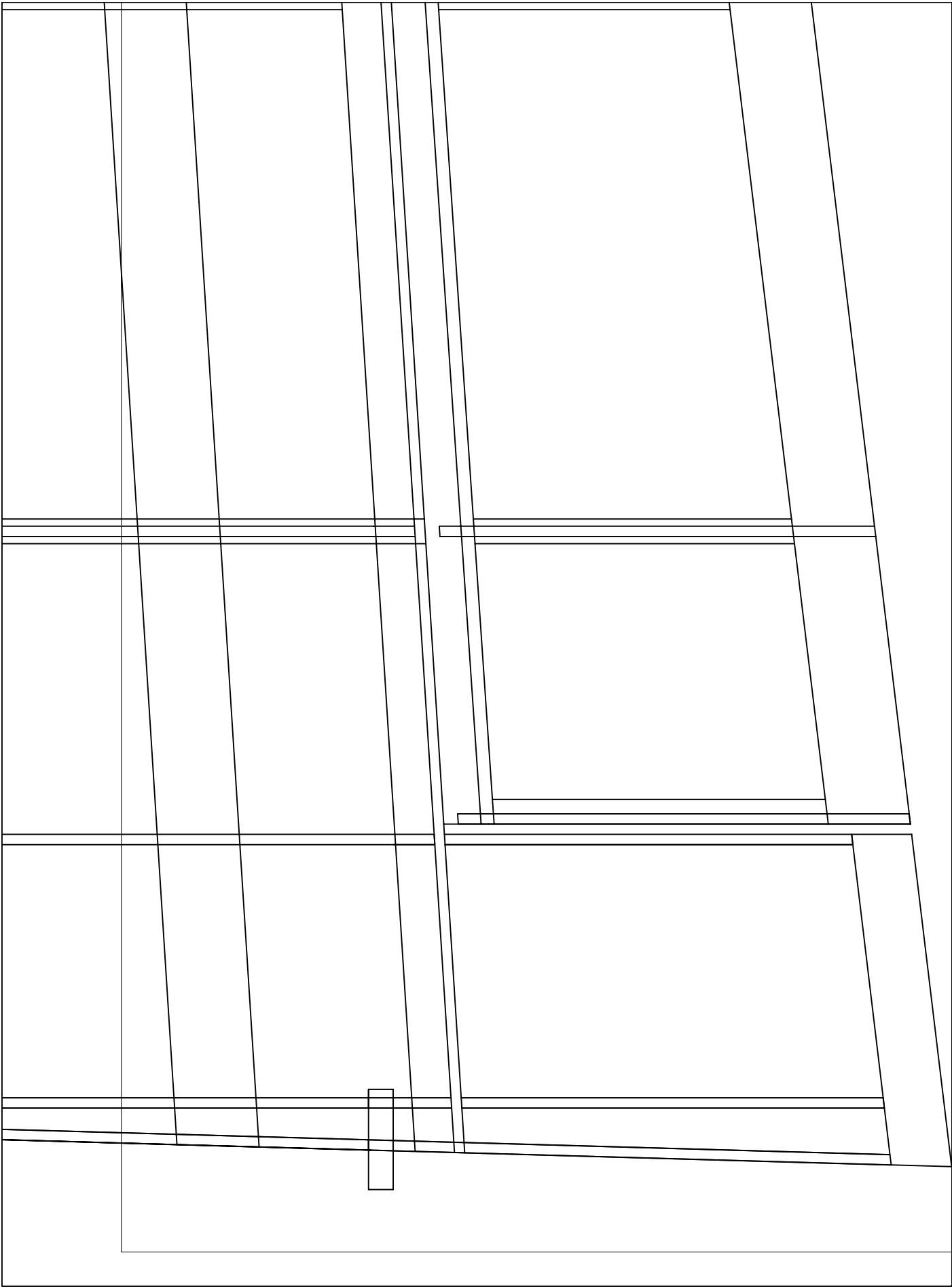

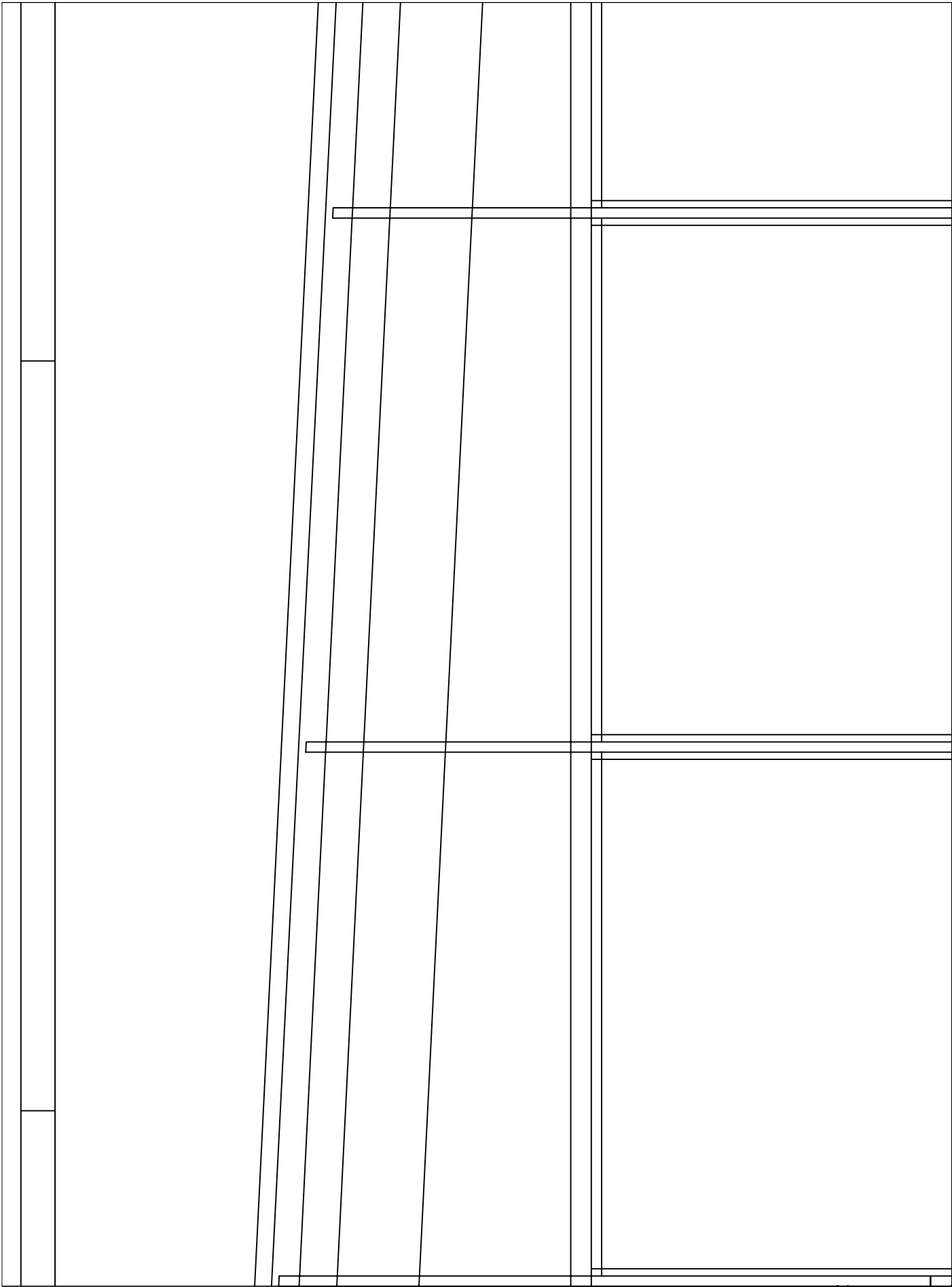

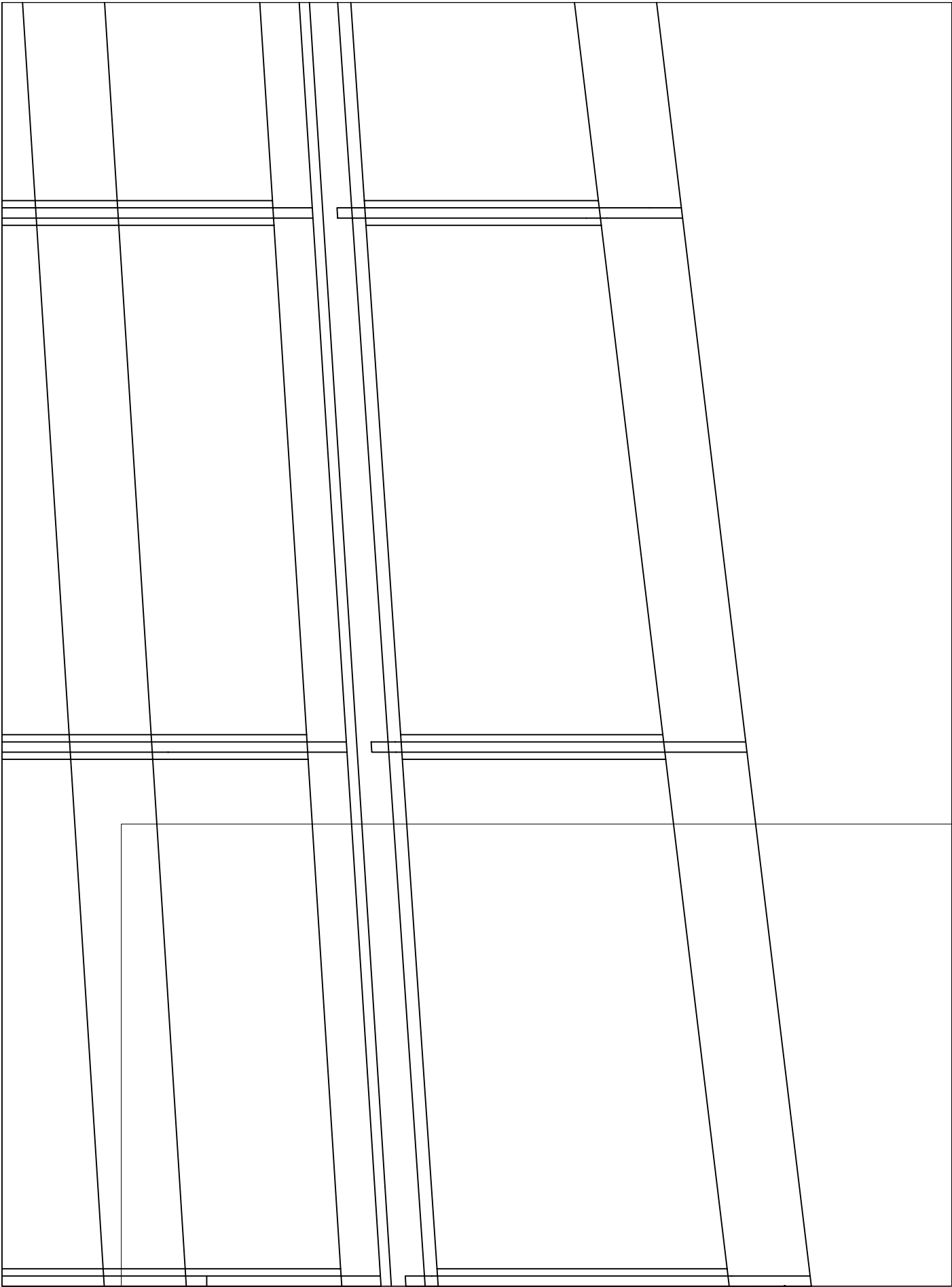

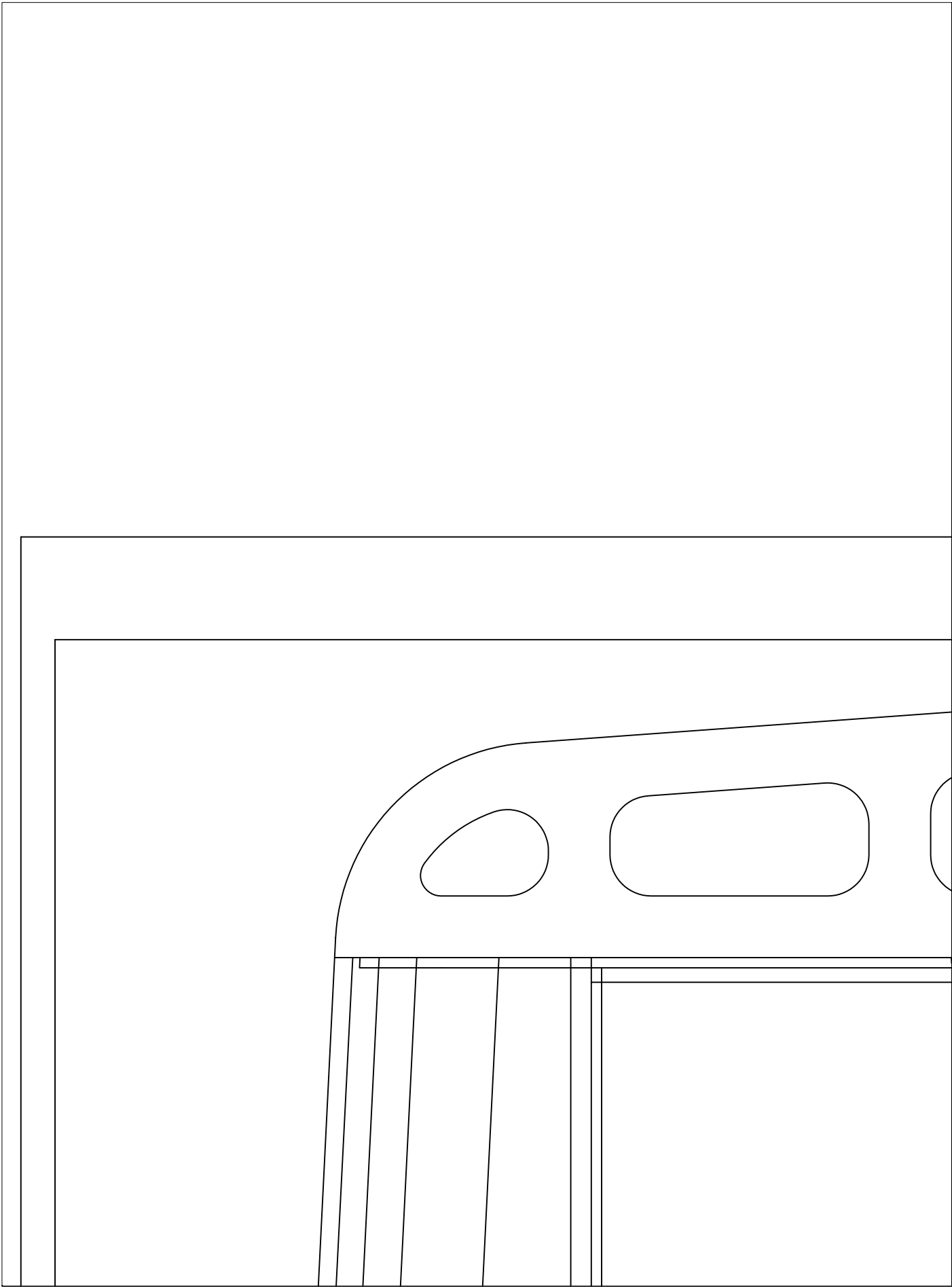

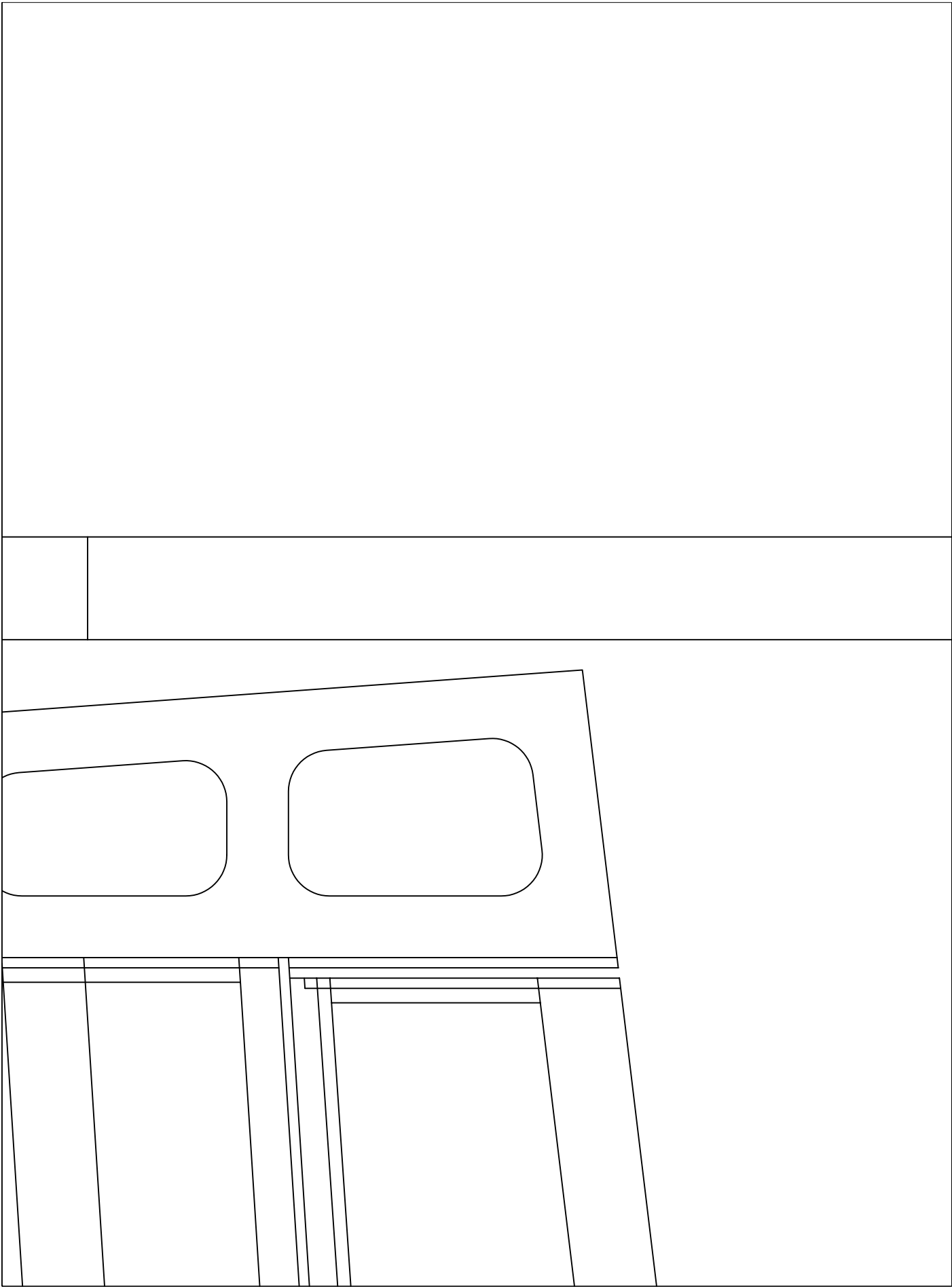

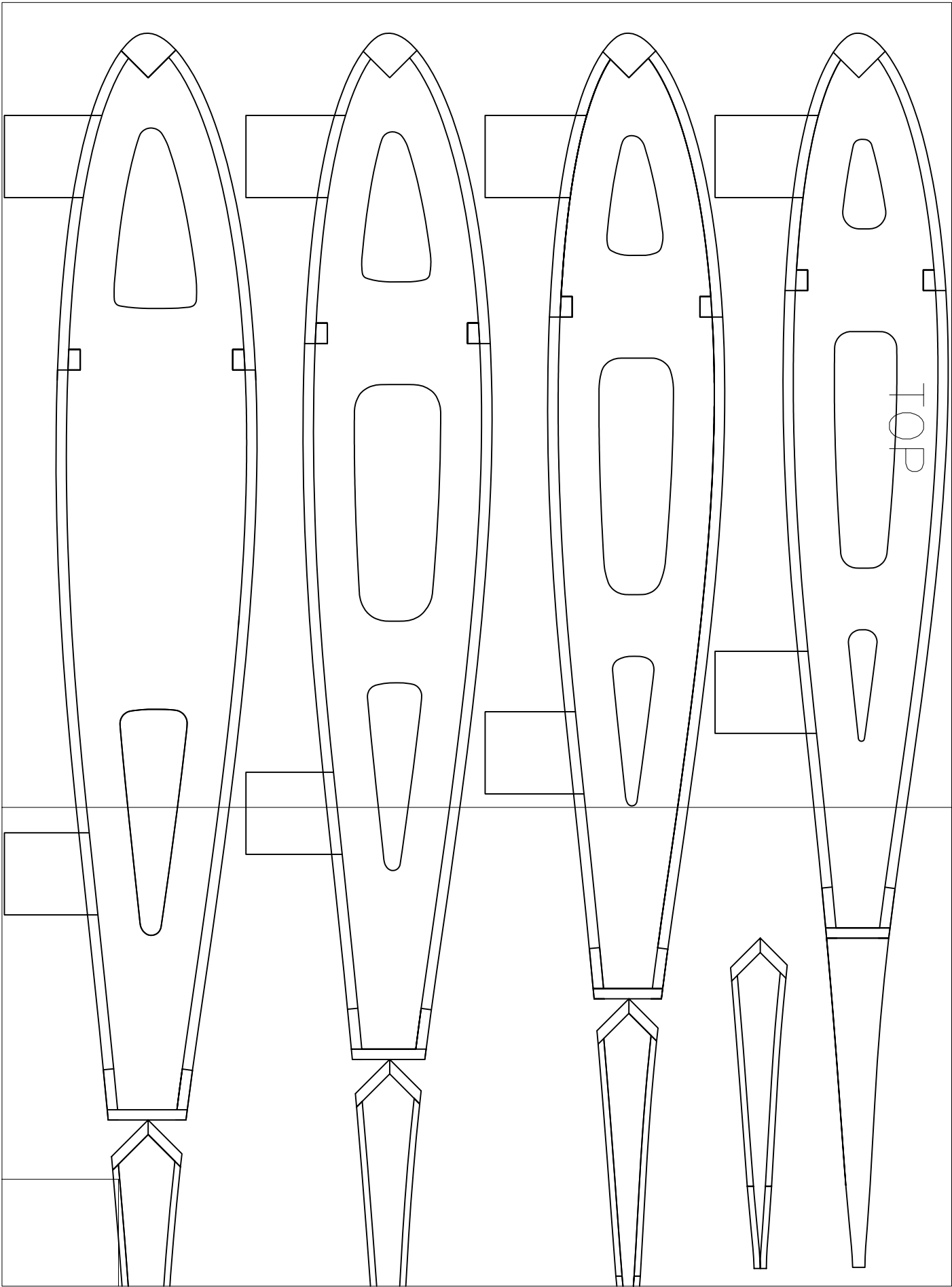

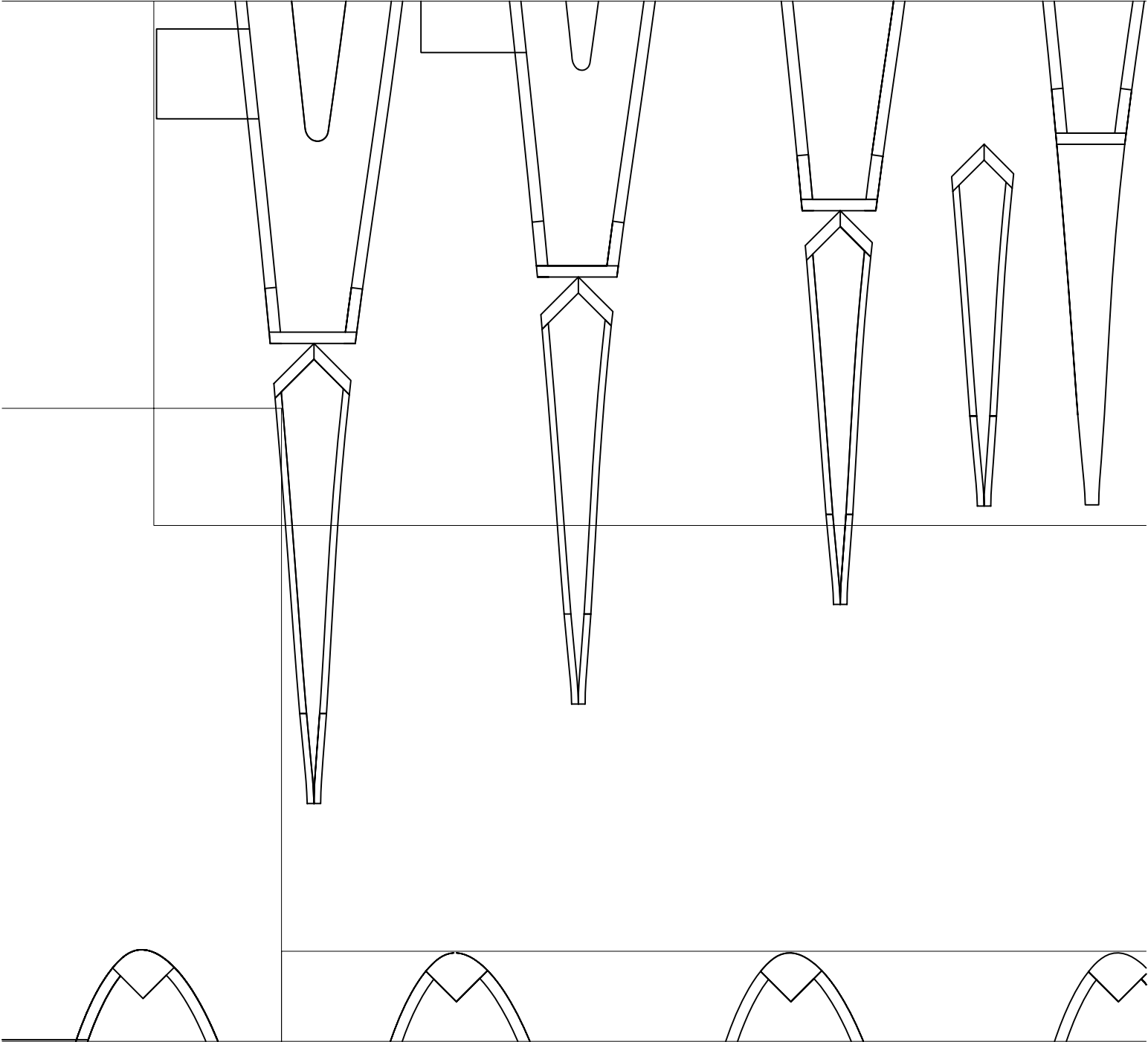

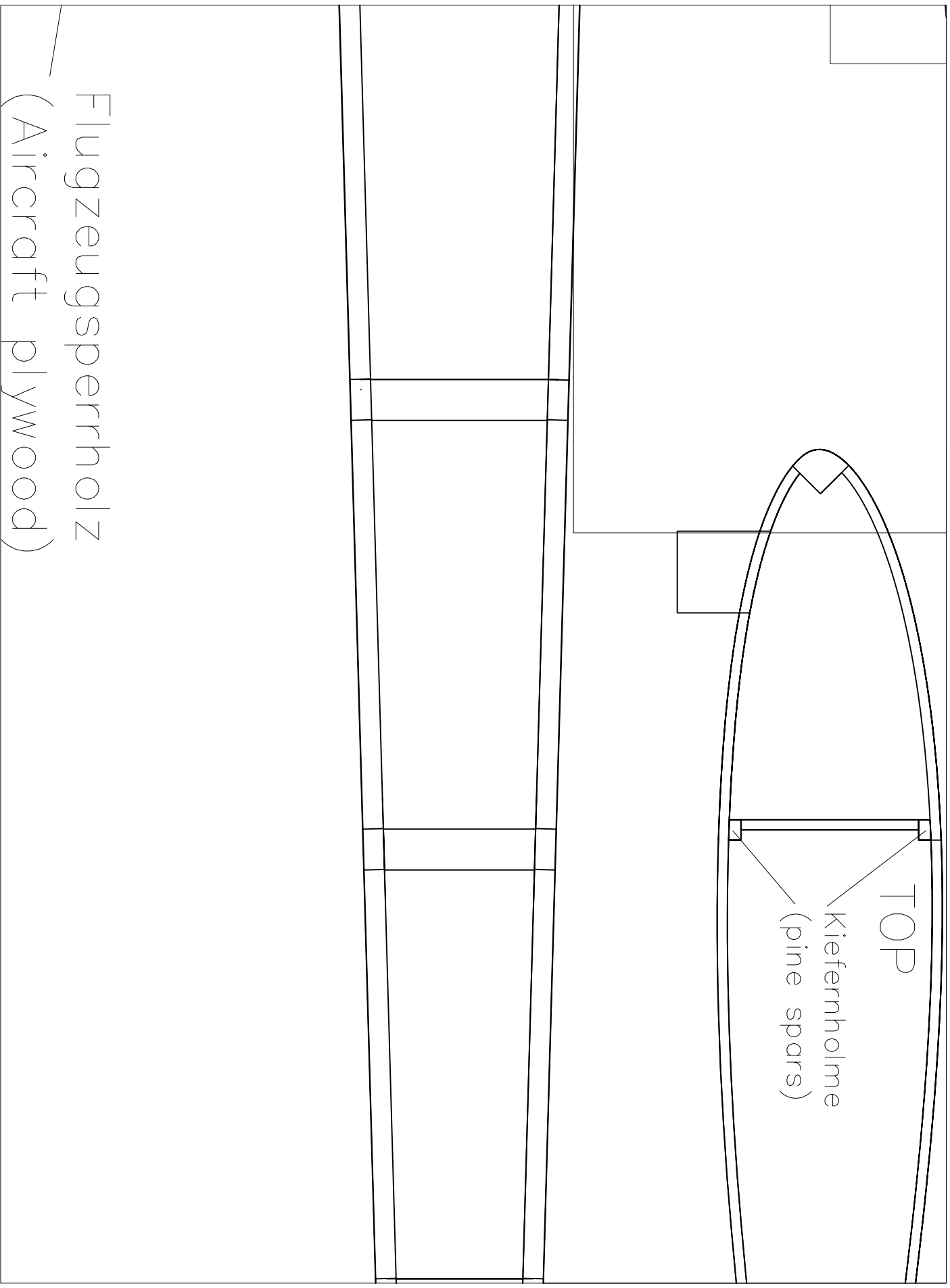

TOP

Kiefernholme
(pine spars)

Flugzeugsperrholz
(Aircraft plywood)

